



JINGDA
PRINTING MACHINERY

JDZ-1030 Single Color Silk-Screen Label Printing Machine

Operation Manual

JDZ-1030 单色丝网印带机

使用说明书

(Welcome to purchase Jingda Printing Machine)

Company :Ruian Jingda Printing Machinery Co.,Ltd

Tel: 0577-65337601 65320208

Fax: 0577 65337602

Add: Dongcheng Industry Zone, Sandu, Tangxia

Town, Ruian city, China.

Website: www.cnjdyj.cn

Email: zhong@cnjdyj.cn

Contents

1. Introduction.....	1
2. Operation segment.....	2
2.1 Unwind segment.....	2
2.2 Printing Part.....	3
2.3 Drying device.....	6
2.4 Conveying belt system.....	6
2.5 Bridge oven and unwinding shaft	6
2.6 Feeding.....	6
3. Cautions and upkeep.....	6
3.1 Cautions.....	6
3.2 Upkeep.....	7
4. Connecting chart.....	8
5. Electricity component table.....	10
6. Circuit diagram.....	10
6.1 Gas circuit general list.....	10
6.2 Circuit general chart.....	11
7. Trouble Phenomenon analysis.....	13
8. List of spare part.....	14

JDZ-1030 Single Color Silk-screen Label Printing Machine

1. Introduction

It adopts separated step and PLC control as one unit with ease of operation and steady running as well as lower trouble.

It adopts printing principle to deal with, roller to roller, separated step to feed- single color printing- ironing drying-sensor fixed position for printing.

It is widely used in any textile, cloth, paper, non-adhesion, PVC etc. material; the printing area is larger and dedicate as well as clear without fading.

This machine is easy to maintain and upkeep, it adopts steel to ensure its precision and prolonging its life of span for parts. Varied assortment of combination and man-machine interface as well as unique structure to make this machine in the leading position.

Please read the operation manual carefully before operating, it will guide the users how to operate, do not operate the machine when you can not understand the operation completely.

Main technical:

Printing Size: 800X600(LXW) mm

Frame size: 700X1100(LXW) mm

Length: 20-600mm It is not allowed to be more than 600(mm)

Width: 600(mm)

Speed: 30-1200 t/h

Printing Machine 220V/50HZ

Rewinder Unit 380V/50HZ

Doctor blade working length: 600mm

Hot wind drying: 500W/220V/ color

Draw motor: 0.4 kw

Doctor blade motor: 0.55kw

Unwinding motor: 0.18kw

Suction motor: 0.37kw

IR drying: 4.5kw

Iron plate power: 0.5kw

Total power: 5KW/220V

Conveying belt specifications: 600 (mm)

Overall dimensions: 250X130X130 (LXWXH)CM

Unwinder: 180X130X130 (LXWXH)CM

Machine Weight: Net weight: 800KG

Gross weight: 850KG

2. Operation segment

2.1 Unwind segment

It is composed of frame, holding circle pad, guiding roller, as well as front pressure roller to ensure its working evenly and equal distance and moderate fastening, moving from unwinding frame to the belt with glue.

2.2 Printing Part

It is composed of some parts with high precision, its parts is composed of inking blade, moveable frame, frame fixed and color running part, wire printing table and electric equipment and circuit part. The working process of every printing unit is given as following:

Start switch: vacuum table to intake the belt, scratch blade down and inking blade up, blade frame moving to the right to the position and stop, inking blade down and scratch blade up, the vacuum stop, the air blow open, the blade frame moving to the left to the original place and enter the next cycle. The distance of the blade frame and the speed is controlled by computer. Its operation interface is give as followed:

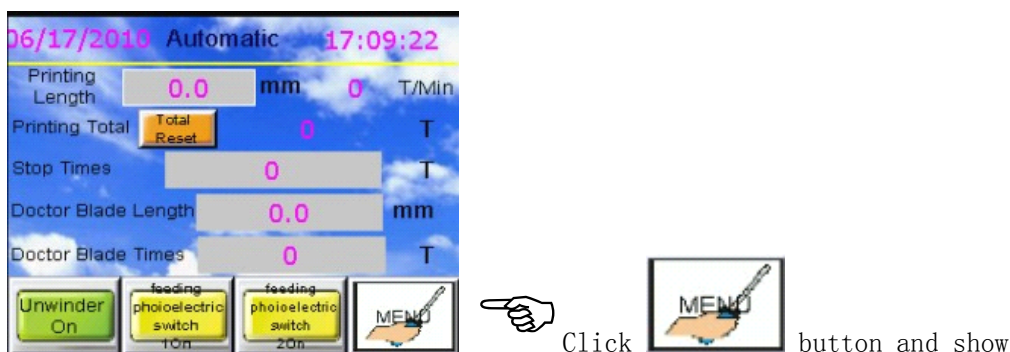

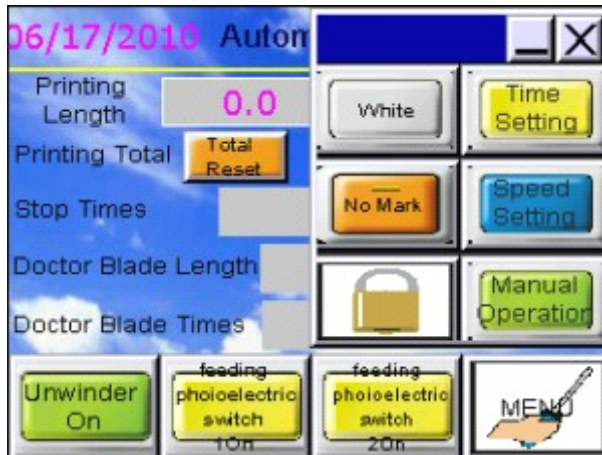

Click  button and show



Click  button and show

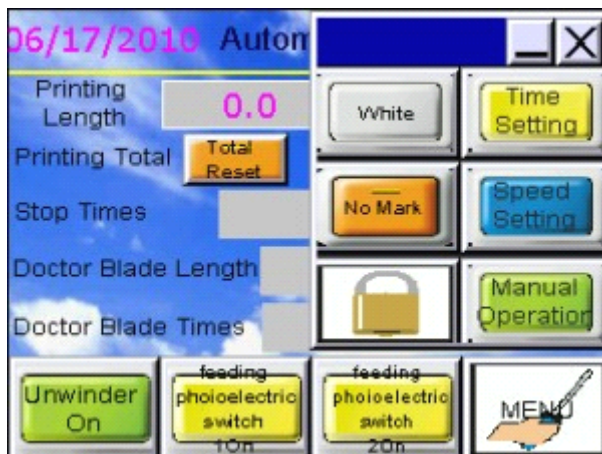
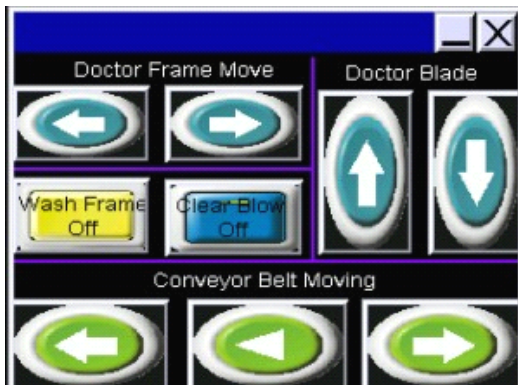

Click  button and show

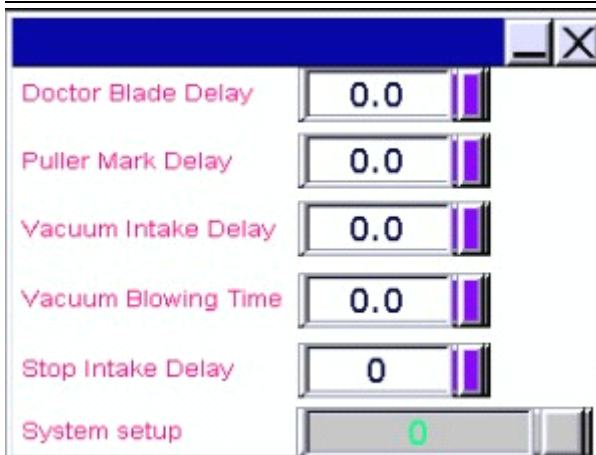

Click  button and show

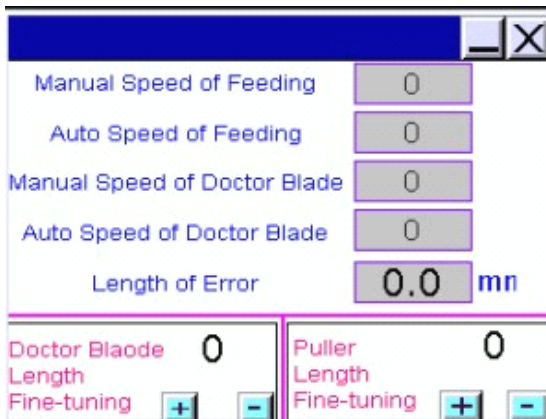

Jingda Printing Machinery Co., Ltd.

Add: Dongcheng Industry Zone, Sandu, Tangxia Town, Ruian city

Tel: 0577-65337601 65320208

JD09070810

Printing Length: (Means the film length which put in screen frame, if the label length is 80mm, and the label image make in the film is 4pcs label image , so we can setting as 320mm(80x4pcs) in the printing length)

Printing Total :(Auto counting, but can be change as 0 when press the screen setting)

Stop Times: (How many label PCS will be printing) remark: when we are printing and want to setting the label pcs , so make sure the printing total number is less than stop times number, or change as 0 in the printing total, for example when the Printing Total is show10pcs, and setting as 5 in the stop



time, the machine just will be run one cycle only and not continue)

Make sure Printing total: 0 /1/2/3....(If the count number is 6000 more than Stop time: 2000 /3000/5000, press screen number of the printing total in a few seconds ,it will be change as 0)

Doctor Blade Length :(during printing area)

Doctor Blade Times: can be 1 or according to you requirement)

Manual

Unwind On

Set T/Min

Left-move

Right-move

Clear blowing

ON

OFF

Front rotation for gluing (when put glue in the conveyor belt, will use that)

Back rotation for gluing

Blade down

Blade up

Start

Conveyor belt moving

Manual speed of feeding (set well before out of factory)

Automatic speed of feeding: (during 500-5500)

Manual speed of doctor blade (set well before out of factory)

Automatic speed of doctor blade:(during 500-5500)

Length of mark: press this key to move the mark

Back

No mark: use this key for twice printing

Sensor indicating Light: for twice printing, the labor material of color is white or light color, mark working of color is used for labor with black or dark black.

Page down

Rotation

Doctor Blade Delay

Vacuum Intake Delay

Stop Intake Delay

Puller Mark Delay

Vacuum Blowing Time

(Set well before out of factory)

2.3 Drying device

It is equipped with ironing plate drying oven, its temperature is not more than 100°C. (This machine has not man-controlled temperature system, do not raise its temperature)

otherwise it will cause the machine out of shape.

2.4 Conveying belt system

There are two methods to convey the belt, when cleaning or replacing the belt or coating glue, press the button ON, the conveying belt will move successively to the right, press the button OFF, it will stop.

2.5. Bridge oven and unwinding shaft

When finishing printing,, through the bridge oven, it is delivered to the last oven to the unwinding, heat it till the temperature is up to 80 °C . The unwinding shaft must be operated till the machine starts. Adjust the tension to control its friction and switch.

After knowing its basic parts, then we will introduce how to operate and the switch role.

Connect the power, the indicating lights are on. When starting the machine, if the air source doesn't work, the machine can not work. Firstly, clean the vacuum room by blowing, then press the button ON for conveying belt. Then do the coating glue evenly. After coating, press the button OFF, the belt stops moving to the right.

2.6 Feeding

Put the machine into the feeding frame then position it, press the ON switch, press the button OFF switch to make the frame fixed. Adjust the blade position to 1mm front to the design. (Open it on the page of the touch-screen, make it sure then press it). Then set the length of the scratch blade. After that, adjust the pressure and angle for blade as well as position of the inking blade. The pressure of the blade is adjusted by the cylinder nut. Its pressure should not be too high. Its angle scope is from 80*45 degree. When the materials is not blocked the photoelectric switch, photoelectric switch should be covered with material or the machine can not be started off. there are two photoelectrical switches, may choose not to work and work.

3. Cautions and upkeep

3.1 Cautions

1. Do not use petrol to clean the belt, all above mentioned happens, we have no responsibility.
2. PLC data and program controller set: before out of the factory all the data of converter and program controller are well set. Do not change it at random. If due to changing the data by users to cause the parts damaged, we don't guarantee to repair. (Users change the data and program, all the revised data will be recorded) if the users want to change the data, please contact suppliers.
3. Do not use petrol to clean the belt, all above mentioned happens, we have no responsibility.
4. PLC data and program controller set: before out of the factory all the data of converter and program controller are well set. Do not change it at random. If due to changing the data by users to cause the parts damaged, we don't guarantee to repair. (Users change the data and program, all the revised data will be recorded) if the users want to change the data, please contact suppliers.

Routinely maintain

1. Linear shaft and linear bear shaft: the guide orbit is the key to ensure the frame moving correctly, so check it and add the oil regularly to ensure it lubricated.
2. Worktable: due to the worktable dirty or something oil etc substance, it will affect the

surface of the worktable level or block the hole of the worktable, it will reduce the ability of vacuum and affect the quality of the product, so rinse the worktable regularly by detergent, make the worktable clean, when cleaning, press the button of blowing to OFF to avoid the dirty things into the hole. Users can use the hammer to make the hole work well. Do not make the detergent or substance into the interior of the machine through the hole. Thus it will cause the vacuum pump damaged.

3. Head: scratching blade and inking blade is equipped on the head. If the ink becomes hard, it will damage the wire net, so it should be cleaned regularly.

4 Compressed air circuit: we hope there is a kind of air source; it must be clean and dry as well as steady. Check the intake two-connecting parts regularly and add 34-40# lubricating oil, 1. Keep this in mind every day after work, short glass should be pour the residual water which is separated. 2. Keep this in mind every day after work, the gas storage barrels should be empty the gas . If we do not operate in accordance with the above two steps ,it will cause a lot of damage for the machine and electromagnetic valve.. The air pressure must not be less than 0.6 pa, but it can not be more than 0.65 pa.

5. Vacuum pump: check the intake filter per week, when rinsing, do not use the detergent water, alcohol, volatilized oil, petrol lamp oil etc. organic solvent. Use the compressed air to rinse. And replace the dirty filter in time.

6. Electric part: keep the button for PLC and every button clean, keep solvent or ink oil out to avoid electric break. Pay attention to the entrance of the electric distributor, do not shield by person to ensure the air to be intake. Fasten the screws for every part. (Generally speaking, due to shaking, some screws must be loosening). What's more, the terminal with blowout fuse may be loose,

Enhance its spring by small screw drivers

7. Step motor

Connect electric power/ cutting off should be done by operator himself.

After cutting off the power, the circuit board still have electricity state for some time, checking should be done after cutting off the power and the indicating light being off. It's about 5 minutes to check. Do not check in the insulation state. It will damage the step motor.

3.2 Upkeep

1. The temperature and the damp is normal or not. Whether something dirty or dust as well as other substance etc.

2. The sound and shaking of the motor can work normally or not, or it is too hot or smell is not normal.

3. The temperature is high or not, its ground is clean or not. The connection is loose or not as well others are not good.

4. The output current is great different from the normal value, the terminal is burnt or not.

5 Environment of workshop:

The working environment should be kept clean and well ventilated. If it is possible, install an air conditioner to make the room damp. It is useful for printing.

4. Connecting chart

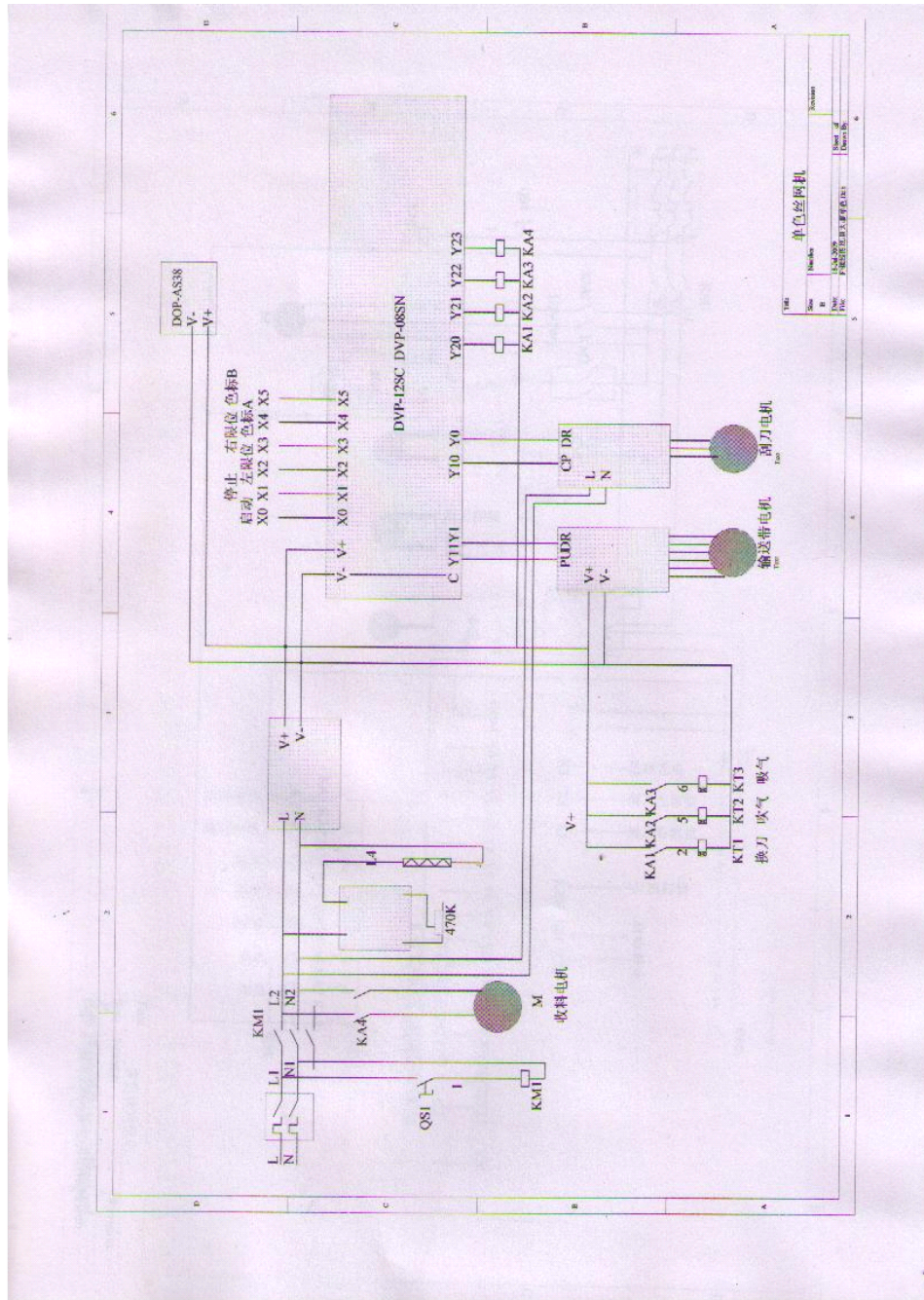

5. Electricity component table

NAME	TYPE	BRAND	NUMBER
PLC	DVP12SC11T	Delta	1
PLC expansion	DVP16SP11T	Delta	1
touch screen	DOP-AS38BSTD	Delta	1
doctor motor	0.4KW	Outeshi	1
Draw motor	0.4KW	Yankong	
Unwinding motor	0.18KW	Yankong	
Emergency Stop	LAS0-AY-11TS	HONGBO	1
button	LAS0-AY-AY11	HONGBO	2
approach switch	TQ5MYL	ORMON	2
photoelectric switch	D201B	MINGWEI	1
Switch power supply	4BN-6G	ORMON	1
contactor	MY2NJ-24V	ORMON	1
Air switch	2P-20A	LG	1
auxiliary relay	32A	LG	1
	40A	AOYI	1
potentiometer		AOYI	1
voltmeter	DVP12SC11T	AOYI	1

6. Circuit diagram

6.1 Gas circuit general list

Model	Name	Qty.	Brand
AFR2000	Filter Pressure Reducing Valve	1	Airtac
4V210-08	Electromagnetic Valve	2	Airtac
3V210-08NC	Electromagnetic Valve	1	Airtac
ASC-10	One-way Throttle Valve	1	Airtac
3A320-10	Pneumatic Valve	1	Airtac
KRX3-P-V/VB	Vacuum Pump	1	Yunwang
SDAJ40X50-15-B	Cylinder	1	Airtac

6.2 Circuit general chart

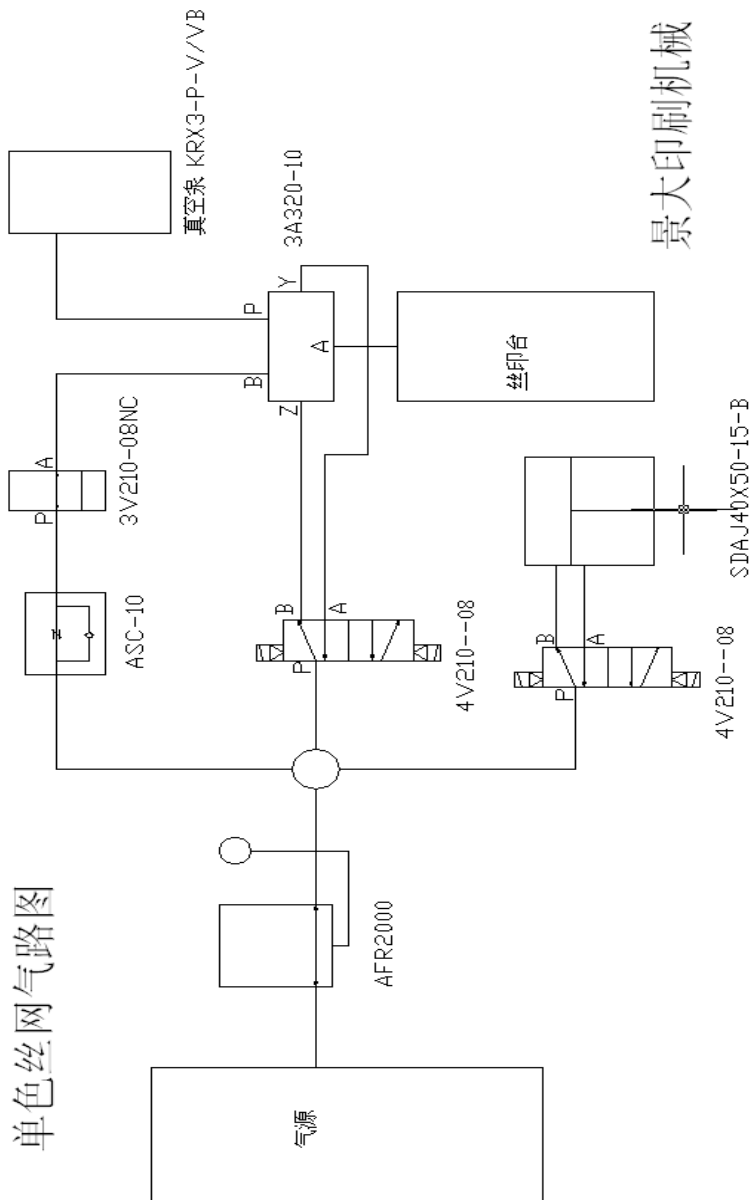

7. Trouble Phenomenon Analysis

Phenomenon	Cause	Solution
Screen warning: Printing head arrives at the approaching switch of the right limit! Please reset!!	1. The length of blade is set too long. 2. Approaching switch is faulty.	1. Reset. 2. Adjust if the front burn-out mask is touched, replace the approaching switch.
Screening warning: Please check the approaching switch of the left limit! Please reset!!	1. Approaching switch is faulty. 2. Mechanical block	1. Adjust if the front burn-out mask is touched, replace the approaching switch. 2. Check if there is trouble



		in the machine or the gearbox
Screen warning: Material photo is not encountered! Or overpass! Please check	1. Material photo is not encountered. 2. Material photo is damaged.	1. Adjust the position of material photo. 2. Replace the switch of material switch.
Machine operates once and stops.	1. Material photo is not encountered. 2. Couple mark opens.	1. Adjust the position of material photo; replace the material photo. 2. Change the couple mark in the first color text into no mark.
Machine stops randomly.	1. Servo failure. 2. Electric failure.	1. Check if the servo of every color has warning; adjust servo according to the servo instruction. 2. Check if the 24V output of the switch power in each color circuit board is normal, if PLC operates normally. Check if the 24V output of the switch power in each color circuit board is normal, if PLC operates normally.
When the machine is switched on, the screen displays connection.	1. Circuit failure. 2. Electric failure.	1. PLC communication is not normal, replace 485 communication line, replace PLC. 2. Check if the 24V output of the switch power in each color circuit board is normal, if PLC operates normally.



8. List of spare parts

No.	Spare Parts Name	Qty.	PS
1	toolbox	1	
2	ruler of 500mm	1	
3	Cross-screwdriver, 6mm in diameter, 100mm long	1	
4	Straight screwdriver, 6mm in diameter, 100mm long	1	
5	Adjustable Wrench of 8 inches	1	
6	Snap-off Knife	1	
7	Inner Hex Wrench	1	
8	High-pressure Oil Gun	1	
9	Ink Blade/Doctor Blade	2	
10	Base Plate	1	Used for cutting tape
11	PVC Conveyor Belt	2	1.7m
12	Screen Frame	5	
13	Photoelectric Switch	1	
14	Vacuum Pump	1	
15	Glue for conveyor belt	1	Materials fixing
16	Operation Instruction of Jingda Circuit Diagram	1	